



RITEL-Knöpfe zeichnen sich durch Formschönheit, Griffigkeit, hohe Haltbarkeit und ein umfangreiches, farbiges Zubehörprogramm aus.

RITEL-Drehknöpfe besitzen vorge-spannte Spannanzgen! Die Schrauben müssen vor der Montage nicht mehr gelöst werden, nur noch aufstecken und anziehen.

Les boutons RITEL se caractérisent par leur présentation soignée, leur grande solidité, l'excellent maintien sur l'axe par fixation à pince de serrage et par un programme complet d'accessoires de couleurs variées.

Les boutons RITEL sont équipés de pinces de serrage à ressort! Il n'est nécessaire de desserrer aucune vis avant le montage, simplement enfoncer et serrer.

RITEL knobs are distinguished by their styling elegance, easy handling, long service life, excellent fit on the shaft as a result of clamping chuck mounting and by their comprehensive accessories program in different colours.

RITEL knobs have preloaded collets! No screws have to be loosened before fitting, push on and tighten only.

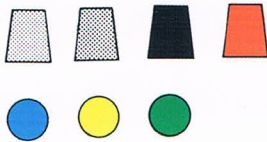

Die RITEL-Drehknöpfe sind in den Ausführungen «standard» und «mat finish» in vier Farben ab Lager lieferbar. Für die Deckel und Pfeile haben wir noch drei zusätzliche Farben ausgewählt. Alle Teile sind auch in Spezialfarben erhältlich.

Tous les modèles de boutons RITEL sont livrables en exécution «standard» et «mat finish» en quatre couleurs. Les capuchons et les disques à flèche existent en trois couleurs supplémentaires. Tous nos boutons et accessoires sont aussi à disposition en couleurs spéciales.

RITEL collet knobs are available in «standard» and «mat finish» in four colours. We have selected three additional colours for caps and arrows. All knobs and accessories are also at your disposal in a large range of special colours.

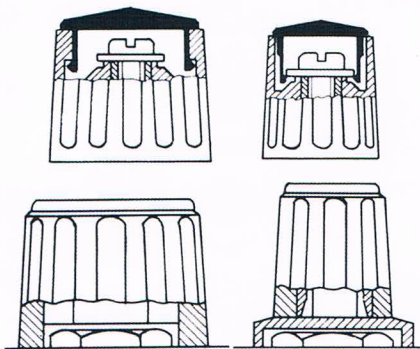

Die Deckel sind in drei Grundausführungen lieferbar: flach, Prismaform und bombiert. Die flachen Deckel mit zusätzlich aufgedrängtem Strich, Pfeil, Schwellpfeil oder mit eingelegter Aluminiumscheibe; die Prismaform mit aufgedrängtem Punkt; die bombierten Deckel mit Strich. Die Deckel sind so konstruiert, dass sie bei der Montage im Knopf einrasten und dadurch unverlierbar sind.

Les capuchons sont livrables en trois exécutions de base: Modèle plat, forme prismatique et forme courbée. Les capuchons plats sont aussi fabriqués avec des repères: trait, flèche, flèche coudée ou avec disque aluminium; les capuchons prismatiques avec point; les capuchons courbés avec trait. Les capuchons sont munis d'un encliquetage qui se verrouille dans le bouton lors du montage.

Caps are sold in three basic models: flat, prismatic or curved. The flat cap can also be furnished with indicator line, arrow, curved arrow or with aluminium disk, the prismatic cap with distinctive point and the curved cap with indicator line. Caps snap into a secure position in the knob.

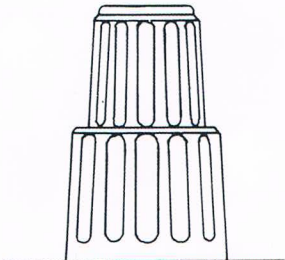

Die Knopfgrößen 21 mm, 28 mm, 36 mm und 45 mm besitzen Aussparungen für Befestigungsmuttern, für 10 mm, 13 mm und 15 mm gibt es Mutterabdeckungen.

Les boutons de diamètre 21 mm, 28 mm, 36 mm et 45 mm possèdent un dégagement pour l'écrou. Ils existent des jupes pour les diamètres de 10, 13 et de 15 mm.

The 21 mm, 28 mm, 36 mm and 45 mm knob sizes have recesses for nuts. For the 10, 13 and 15 mm sizes nut covers are available.

Drehknöpfe mit durchgehender Spannanzange für Doppelknöpfe sind ebenfalls lieferbar. Nähere Angaben finden Sie auf den Seiten 30 und 31.

Les boutons doubles avec pince de serrage pour axes coaxiaux sont aussi livrables, vous trouverez les détails aux pages 30 et 31.

Knobs with coaxial collet for double knobs are also available. Detailed information on pages 30 and 31.

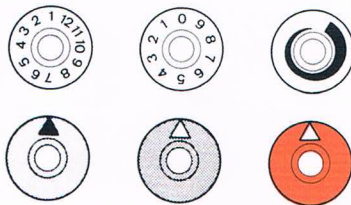

Eine grosse Anzahl von Zahlenscheiben für Rastereinstellungen 27°40', 30°, 36° und 60°, sowie farbige Scheiben ersparen Ihnen teure Sonderanfertigungen.

Le grand choix de cadrans gravés pour angles de positionnement de 27°40', 30°, 36° et 60° vous évite la réalisation de platines frontales coûteuses.

A large selection of figure dials for indexing angles of 27°40', 30°, 36° and 60° together with coloured disks dispense with the need for expensive manufacture of special units.

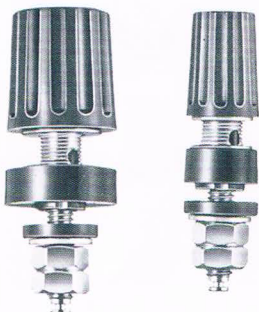

Die in acht Farben lieferbaren RITEL-Industrieklemmen sind eine Ergänzung zum RITEL-Drehknopfprogramm.

Les pinces industrielles RITEL, livrables en huit couleurs, constituent une extension du programme de boutons RITEL.

The RITEL industrial terminal, available in eight colours, is a supplement to the RITEL range of knobs.

Vielleicht finden Sie trotz des umfangreichen Sortiments «Ihren» Knopf nicht in unserem Programm. Wir sind gerne bereit, Ihnen Spezialknöpfe oder Zubehörteile nach Ihren Zeichnungen oder Ihren Mustern zu offerieren.

Si malgré la grande étendue de notre assortiment vous ne trouvez pas «Votre» bouton dans notre programme, nous vous offrirons volontiers une exécution spéciale conforme à vos dessins ou échantillons.

If you did not find «your» particular knob in our vast collection, please do not hesitate to contact us. We shall be pleased to offer you special knobs and accessories to your specifications.

Knopf
Bouton
Knob

Knebelknopf
Bouton à oreilles
Wing knob

Pfeilknopf
Bouton à flèche
Arrow knob

8 mm



10 mm



13 mm



15 mm



21 mm



28 mm



36 mm



45 mm



Inhalt

Seite

Einführung		2, 3, 4, 5
Drehmomente		5
Spez. Zubehör		6
Knopf, Deckel	8	7
	10	8, 9
	13	10, 11
	15	12, 13
	21	14, 15
	28	16, 17
	36	18, 19
	45	20, 21
Statoren		26, 27
Zahlenscheiben		26, 27
Pfeilscheiben		26, 27
Pfeile		28
Mutterabd.		29
Kurzknöpfe	15	22, 23
	21	24, 25, 26
	28	24, 25, 26
	36	24, 25, 26
Knöpfe mit durchgehender Spannz.		30
Doppelknöpfe		31
Zwischendeckel		31
Steckknöpfe		32, 33
Industrieklemmen		34
Industrieklemmen berührungssicher		35
Introduction		2, 3, 4, 5
Couples		5
Accessoires spéciaux		6
Bouton, couvercle	8	7
	10	8, 9
	13	10, 11
	15	12, 13
	21	14, 15
	28	16, 17
	36	18, 19
	45	20, 21
Stators		26, 27
Cadrams		26, 27
Disques à flèche		26, 27
Flèches		28
Couvre-écrous		29
Boutons courts	15	22, 23
	21	24, 25, 26
	28	24, 25, 26
	36	24, 25, 26
Boutons avec pince de serrage traversante		30
Boutons doubles		31
Couvercles intermédiaires		31
Boutons embrochables		32, 33
Bornes industrielles		34
Bornes industrielles protégées contre le toucher		35
Introduction		2, 3, 4, 5
Torques		5
Spec. accessories		6
Knob, cover	8	7
	10	8, 9
	13	10, 11
	15	12, 13
	21	14, 15
	28	16, 17
	36	18, 19
	45	20, 21
Stators		26, 27
Number wheels		26, 27
Arrow plates		26, 27
Arrows		28
Nut cover		29
Short knobs	15	22, 23
	21	24, 25, 26
	28	24, 25, 26
	36	24, 25, 26
Knobs with continuous collet		30
Double knobs		31
Intermediate cover		31
Push-on knobs		32, 33
Industrial terminals		34
Industrial terminals shockproof		35

Knopf Bouton Knob

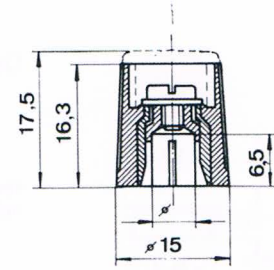

mit Strich — avec repère — with line

	φ				
standard	3	20 15 30 1	20 15 30 2	20 15 30 3	20 15 30 4
	1/8"	20 15 31 1	20 15 31 2	20 15 31 3	20 15 31 4
	4	20 15 40 1	20 15 40 2	20 15 40 3	20 15 40 4
	6	20 15 60 1	20 15 60 2	20 15 60 3	20 15 60 4
	1/4"	20 15 61 1	20 15 61 2	20 15 61 3	20 15 61 4
mat finish	3	26 15 30 1	26 15 30 2	26 15 30 3	26 15 30 4
	1/8"	26 15 31 1	26 15 31 2	26 15 31 3	26 15 31 4
	4	26 15 40 1	26 15 40 2	26 15 40 3	26 15 40 4
	6	26 15 60 1	26 15 60 2	26 15 60 3	26 15 60 4
	1/4"	26 15 61 1	26 15 61 2	26 15 61 3	26 15 61 4

standard	21 15 30 1	21 15 30 2	21 15 30 3	21 15 30 4
	21 15 31 1	21 15 31 2	21 15 31 3	21 15 31 4
	21 15 40 1	21 15 40 2	21 15 40 3	21 15 40 4
	21 15 60 1	21 15 60 2	21 15 60 3	21 15 60 4
	21 15 61 1	21 15 61 2	21 15 61 3	21 15 61 4
mat finish	27 15 30 1	27 15 30 2	27 15 30 3	27 15 30 4
	27 15 31 1	27 15 31 2	27 15 31 3	27 15 31 4
	27 15 40 1	27 15 40 2	27 15 40 3	27 15 40 4
	27 15 60 1	27 15 60 2	27 15 60 3	27 15 60 4
	27 15 61 1	27 15 61 2	27 15 61 3	27 15 61 4

Knebelknopf Bouton à oreilles Wing knob

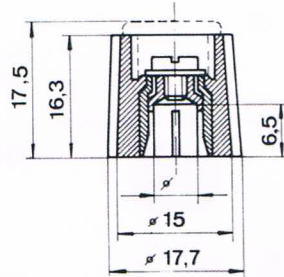

mit Strich — avec repère — with line

	φ				
standard	3	22 15 30 1	22 15 30 2	22 15 30 3	22 15 30 4
	1/8"	22 15 31 1	22 15 31 2	22 15 31 3	22 15 31 4
	4	22 15 40 1	22 15 40 2	22 15 40 3	22 15 40 4
	6	22 15 60 1	22 15 60 2	22 15 60 3	22 15 60 4
	1/4"	22 15 61 1	22 15 61 2	22 15 61 3	22 15 61 4
mat finish	3	28 15 30 1	28 15 30 2	28 15 30 3	28 15 30 4
	1/8"	28 15 31 1	28 15 31 2	28 15 31 3	28 15 31 4
	4	28 15 40 1	28 15 40 2	28 15 40 3	28 15 40 4
	6	28 15 60 1	28 15 60 2	28 15 60 3	28 15 60 4
	1/4"	28 15 61 1	28 15 61 2	28 15 61 3	28 15 61 4

standard	23 15 30 1	23 15 30 2	23 15 30 3	23 15 30 4
	23 15 31 1	23 15 31 2	23 15 31 3	23 15 31 4
	23 15 40 1	23 15 40 2	23 15 40 3	23 15 40 4
	23 15 60 1	23 15 60 2	23 15 60 3	23 15 60 4
	23 15 61 1	23 15 61 2	23 15 61 3	23 15 61 4
mat finish	29 15 30 1	29 15 30 2	29 15 30 3	29 15 30 4
	29 15 31 1	29 15 31 2	29 15 31 3	29 15 31 4
	29 15 40 1	29 15 40 2	29 15 40 3	29 15 40 4
	29 15 60 1	29 15 60 2	29 15 60 3	29 15 60 4
	29 15 61 1	29 15 61 2	29 15 61 3	29 15 61 4

Pfeilknopf Bouton à flèche Arrow knob

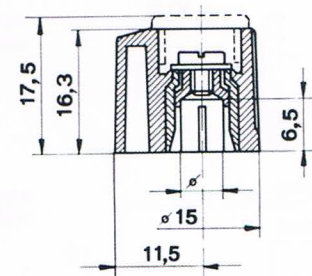

mit Strich — avec repère — with line

	φ				
standard	3	18 15 30 1	18 15 30 2	18 15 30 3	18 15 30 4
	1/8"	18 15 31 1	18 15 31 2	18 15 31 3	18 15 31 4
	4	18 15 40 1	18 15 40 2	18 15 40 3	18 15 40 4
	6	18 15 60 1	18 15 60 2	18 15 60 3	18 15 60 4
	1/4"	18 15 61 1	18 15 61 2	18 15 61 3	18 15 61 4
mat finish	3	16 15 30 1	16 15 30 2	16 15 30 3	16 15 30 4
	1/8"	16 15 31 1	16 15 31 2	16 15 31 3	16 15 31 4
	4	16 15 40 1	16 15 40 2	16 15 40 3	16 15 40 4
	6	16 15 60 1	16 15 60 2	16 15 60 3	16 15 60 4
	1/4"	16 15 61 1	16 15 61 2	16 15 61 3	16 15 61 4

standard	19 15 30 1	19 15 30 2	19 15 30 3	19 15 30 4
	19 15 31 1	19 15 31 2	19 15 31 3	19 15 31 4
	19 15 40 1	19 15 40 2	19 15 40 3	19 15 40 4
	19 15 60 1	19 15 60 2	19 15 60 3	19 15 60 4
	19 15 61 1	19 15 61 2	19 15 61 3	19 15 61 4
mat finish	17 15 30 1	17 15 30 2	17 15 30 3	17 15 30 4
	17 15 31 1	17 15 31 2	17 15 31 3	17 15 31 4
	17 15 40 1	17 15 40 2	17 15 40 3	17 15 40 4
	17 15 60 1	17 15 60 2	17 15 60 3	17 15 60 4
	17 15 61 1	17 15 61 2	17 15 61 3	17 15 61 4

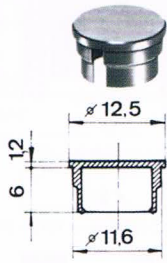

mit Strich
avec trait
with line

mit Schwellpfeil
avec flèche coudée
with curved arrow

mit Pfeil
avec flèche
with arrow

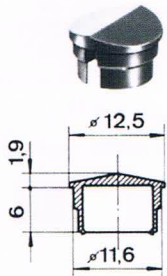

mit Punkt
avec point
with point

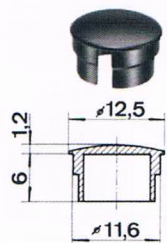

mit Strich
avec trait
with line

mit Aluminium-Scheibe
avec disque aluminium
with aluminium disk

mit Alu-Scheibe und Strich
avec disque alu et repère
with alu disk and line

Deckel flach — Capuchon plat — Flat cap

standard	30 15 00 1	30 15 00 2	30 15 00 3	30 15 00 4	30 15 00 5	30 15 00 6	30 15 00 7
mat finish	30 15 10 1	30 15 10 2	30 15 10 3	30 15 10 4	30 15 10 5	30 15 10 6	30 15 10 7
standard	30 15 01 1	30 15 01 2	30 15 01 3	30 15 01 4	30 15 01 5	30 15 01 6	30 15 01 7
mat finish	30 15 11 1	30 15 11 2	30 15 11 3	30 15 11 4	30 15 11 5	30 15 11 6	30 15 11 7
standard	30 15 02 1	30 15 02 2	30 15 02 3	30 15 02 4	30 15 02 5	30 15 02 6	30 15 02 7
mat finish	30 15 12 1	30 15 12 2	30 15 12 3	30 15 12 4	30 15 12 5	30 15 12 6	30 15 12 7
standard	30 15 03 1	30 15 03 2	30 15 03 3	30 15 03 4	30 15 03 5	30 15 03 6	30 15 03 7
mat finish	30 15 13 1	30 15 13 2	30 15 13 3	30 15 13 4	30 15 13 5	30 15 13 6	30 15 13 7

Deckel prismaform — Capuchon prismatique — Prismatic cap

standard	31 15 00 1	31 15 00 2	31 15 00 3	31 15 00 4	31 15 00 5	31 15 00 6	31 15 00 7
mat finish	31 15 10 1	31 15 10 2	31 15 10 3	31 15 10 4	31 15 10 5	31 15 10 6	31 15 10 7
standard	31 15 04 1	31 15 04 2	31 15 04 3	31 15 04 4	31 15 04 5	31 15 04 6	31 15 04 7
mat finish	31 15 14 1	31 15 14 2	31 15 14 3	31 15 14 4	31 15 14 5	31 15 14 6	31 15 14 7

Deckel bombiert — Capuchon courbé — Curved cap

standard	32 15 00 1	32 15 00 2	32 15 00 3	32 15 00 4	32 15 00 5	32 15 00 6	32 15 00 7
mat finish	32 15 10 1	32 15 10 2	32 15 10 3	32 15 10 4	32 15 10 5	32 15 10 6	32 15 10 7
standard	32 15 01 1	32 15 01 2	32 15 01 3	32 15 01 4	32 15 01 5	32 15 01 6	32 15 01 7
mat finish	32 15 11 1	32 15 11 2	32 15 11 3	32 15 11 4	32 15 11 5	32 15 11 6	32 15 11 7

Deckel flach — Capuchon plat — Flat cap

standard	35 15 00 1	35 15 00 2	35 15 00 3	35 15 00 4
mat finish	35 15 10 1	35 15 10 2	35 15 10 3	35 15 10 4
standard	35 15 01 1	35 15 01 2	35 15 01 3	35 15 01 4
mat finish	35 15 11 1	35 15 11 2	35 15 11 3	35 15 11 4

**Knopf
Bouton
Knob**



	φ				
standard	3	20 21 30 1	20 21 30 2	20 21 30 3	20 21 30 4
	1/8"	20 21 31 1	20 21 31 2	20 21 31 3	20 21 31 4
	4	20 21 40 1	20 21 40 2	20 21 40 3	20 21 40 4
	6	20 21 60 1	20 21 60 2	20 21 60 3	20 21 60 4
mat finish	1/4"	20 21 61 1	20 21 61 2	20 21 61 3	20 21 61 4
	3	26 21 30 1	26 21 30 2	26 21 30 3	26 21 30 4
	1/8"	26 21 31 1	26 21 31 2	26 21 31 3	26 21 31 4
	4	26 21 40 1	26 21 40 2	26 21 40 3	26 21 40 4
	6	26 21 60 1	26 21 60 2	26 21 60 3	26 21 60 4
	1/4"	26 21 61 1	26 21 61 2	26 21 61 3	26 21 61 4

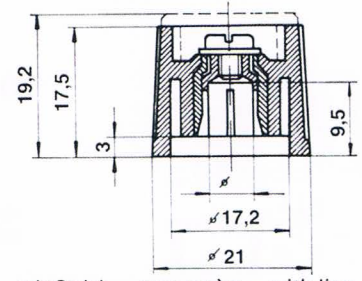

mit Strich – avec repère – with line

21 21 30 1	21 21 30 2	21 21 30 3	21 21 30 4	
21 21 31 1	21 21 31 2	21 21 31 3	21 21 31 4	
21 21 40 1	21 21 40 2	21 21 40 3	21 21 40 4	
21 21 60 1	21 21 60 2	21 21 60 3	21 21 60 4	
21 21 61 1	21 21 61 2	21 21 61 3	21 21 61 4	
27 21 30 1	27 21 30 2	27 21 30 3	27 21 30 4	
27 21 31 1	27 21 31 2	27 21 31 3	27 21 31 4	
27 21 40 1	27 21 40 2	27 21 40 3	27 21 40 4	
27 21 60 1	27 21 60 2	27 21 60 3	27 21 60 4	
27 21 61 1	27 21 61 2	27 21 61 3	27 21 61 4	

**Knebelknopf
Bouton à oreilles
Wing knob**



	φ				
standard	3	22 21 30 1	22 21 30 2	22 21 30 3	22 21 30 4
	1/8"	22 21 31 1	22 21 31 2	22 21 31 3	22 21 31 4
	4	22 21 40 1	22 21 40 2	22 21 40 3	22 21 40 4
	6	22 21 60 1	22 21 60 2	22 21 60 3	22 21 60 4
mat finish	1/4"	22 21 61 1	22 21 61 2	22 21 61 3	22 21 61 4
	3	28 21 30 1	28 21 30 2	28 21 30 3	28 21 30 4
	1/8"	28 21 31 1	28 21 31 2	28 21 31 3	28 21 31 4
	4	28 21 40 1	28 21 40 2	28 21 40 3	28 21 40 4
	6	28 21 60 1	28 21 60 2	28 21 60 3	28 21 60 4
	1/4"	28 21 61 1	28 21 61 2	28 21 61 3	28 21 61 4

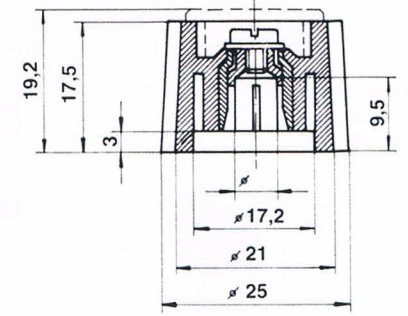

mit Strich – avec repère – with line

23 21 30 1	23 21 30 2	23 21 30 3	23 21 30 4	
23 21 31 1	23 21 31 2	23 21 31 3	23 21 31 4	
23 21 40 1	23 21 40 2	23 21 40 3	23 21 40 4	
23 21 60 1	23 21 60 2	23 21 60 3	23 21 60 4	
23 21 61 1	23 21 61 2	23 21 61 3	23 21 61 4	
29 21 30 1	29 21 30 2	29 21 30 3	29 21 30 4	
29 21 31 1	29 21 31 2	29 21 31 3	29 21 31 4	
29 21 40 1	29 21 40 2	29 21 40 3	29 21 40 4	
29 21 60 1	29 21 60 2	29 21 60 3	29 21 60 4	
29 21 61 1	29 21 61 2	29 21 61 3	29 21 61 4	

**Pfeilknopf
Bouton à flèche
Arrow knob**



	φ				
standard	3	18 21 30 1	18 21 30 2	18 21 30 3	18 21 30 4
	1/8"	18 21 31 1	18 21 31 2	18 21 31 3	18 21 31 4
	4	18 21 40 1	18 21 40 2	18 21 40 3	18 21 40 4
	6	18 21 60 1	18 21 60 2	18 21 60 3	18 21 60 4
mat finish	1/4"	18 21 61 1	18 21 61 2	18 21 61 3	18 21 61 4
	3	16 21 30 1	16 21 30 2	16 21 30 3	16 21 30 4
	1/8"	16 21 31 1	16 21 31 2	16 21 31 3	16 21 31 4
	4	16 21 40 1	16 21 40 2	16 21 40 3	16 21 40 4
	6	16 21 60 1	16 21 60 2	16 21 60 3	16 21 60 4
	1/4"	16 21 61 1	16 21 61 2	16 21 61 3	16 21 61 4

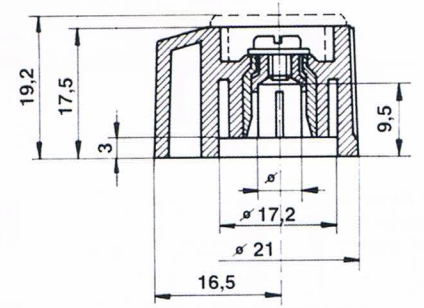

mit Strich – avec repère – with line

19 21 30 1	19 21 30 2	19 21 30 3	19 21 30 4	
19 21 31 1	19 21 31 2	19 21 31 3	19 21 31 4	
19 21 40 1	19 21 40 2	19 21 40 3	19 21 40 4	
19 21 60 1	19 21 60 2	19 21 60 3	19 21 60 4	
19 21 61 1	19 21 61 2	19 21 61 3	19 21 61 4	
17 21 30 1	17 21 30 2	17 21 30 3	17 21 30 4	
17 21 31 1	17 21 31 2	17 21 31 3	17 21 31 4	
17 21 40 1	17 21 40 2	17 21 40 3	17 21 40 4	
17 21 60 1	17 21 60 2	17 21 60 3	17 21 60 4	
17 21 61 1	17 21 61 2	17 21 61 3	17 21 61 4	

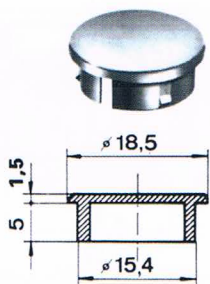

mit Strich
avec trait
with line

mit Schwellpfeil
avec flèche coudée
with curved arrow

mit Pfeil
avec flèche
with arrow

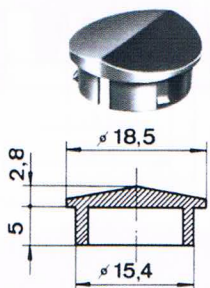

mit Punkt
avec point
with point

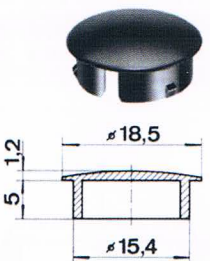

mit Strich
avec trait
with line

mit Aluminium-Scheibe
avec disque aluminium
with aluminium disk

mit Alu-Scheibe und Strich
avec disque alu et repère
with alu disk and line

Deckel flach – Capuchon plat – Flat cap

standard	30 21 00 1	30 21 00 2	30 21 00 3	30 21 00 4	30 21 00 5	30 21 00 6	30 21 00 7
mat finish	30 21 10 1	30 21 10 2	30 21 10 3	30 21 10 4	30 21 10 5	30 21 10 6	30 21 10 7
standard	30 21 01 1	30 21 01 2	30 21 01 3	30 21 01 4	30 21 01 5	30 21 01 6	30 21 01 7
mat finish	30 21 11 1	30 21 11 2	30 21 11 3	30 21 11 4	30 21 11 5	30 21 11 6	30 21 11 7
standard	30 21 02 1	30 21 02 2	30 21 02 3	30 21 02 4	30 21 02 5	30 21 02 6	30 21 02 7
mat finish	30 21 12 1	30 21 12 2	30 21 12 3	30 21 12 4	30 21 12 5	30 21 12 6	30 21 12 7
standard	30 21 03 1	30 21 03 2	30 21 03 3	30 21 03 4	30 21 03 5	30 21 03 6	30 21 03 7
mat finish	30 21 13 1	30 21 13 2	30 21 13 3	30 21 13 4	30 21 13 5	30 21 13 6	30 21 13 7

Deckel prismaform – Capuchon prismatique – Prismatic cap

standard	31 21 00 1	31 21 00 2	31 21 00 3	31 21 00 4	31 21 00 5	31 21 00 6	31 21 00 7
mat finish	31 21 10 1	31 21 10 2	31 21 10 3	31 21 10 4	31 21 10 5	31 21 10 6	31 21 10 7
standard	31 21 04 1	31 21 04 2	31 21 04 3	31 21 04 4	31 21 04 5	31 21 04 6	31 21 04 7
mat finish	31 21 14 1	31 21 14 2	31 21 14 3	31 21 14 4	31 21 14 5	31 21 14 6	31 21 14 7

Deckel bombiert – Capuchon courbé – Curved cap

standard	32 21 00 1	32 21 00 2	32 21 00 3	32 21 00 4	32 21 00 5	32 21 00 6	32 21 00 7
mat finish	32 21 10 1	32 21 10 2	32 21 10 3	32 21 10 4	32 21 10 5	32 21 10 6	32 21 10 7
standard	32 21 01 1	32 21 01 2	32 21 01 3	32 21 01 4	32 21 01 5	32 21 01 6	32 21 01 7
mat finish	32 21 11 1	32 21 11 2	32 21 11 3	32 21 11 4	32 21 11 5	32 21 11 6	32 21 11 7

Deckel flach – Capuchon plat – Flat cap

standard	35 21 00 1	35 21 00 2	35 21 00 3	35 21 00 4
mat finish	35 21 10 1	35 21 10 2	35 21 10 3	35 21 10 4
standard	35 21 01 1	35 21 01 2	35 21 01 3	35 21 01 4
mat finish	35 21 11 1	35 21 11 2	35 21 11 3	35 21 11 4

Zahlscheibe – Cadran – Figure dial

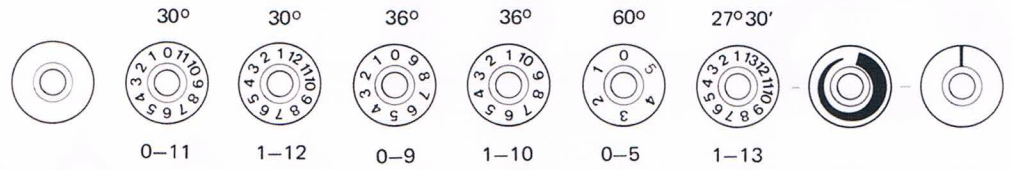

8 mm	46 08 00 0	46 08 01 0	46 08 02 0	46 08 03 0	46 08 04 0	46 08 05 0	46 08 06 0	46 08 10 0	46 08 11 0
10 mm	46 10 00 0	46 10 01 0	46 10 02 0	46 10 03 0	46 10 04 0	46 10 05 0	46 10 06 0	46 10 10 0	46 10 11 0
13 mm	46 13 00 0	46 13 01 0	46 13 02 0	46 13 03 0	46 13 04 0	46 13 05 0	46 13 06 0	46 13 10 0	46 13 11 0
15 mm	46 15 00 0	46 15 01 0	46 15 02 0	46 15 03 0	46 15 04 0	46 15 05 0	46 15 06 0	46 15 10 0	46 15 11 0
21 mm	46 21 00 0	46 21 01 0	46 21 02 0	46 21 03 0	46 21 04 0	46 21 05 0	46 21 06 0	46 21 10 0	46 21 11 0
28 mm	46 28 00 0	46 28 01 0	46 28 02 0	46 28 03 0	46 28 04 0	46 28 05 0	46 28 06 0	46 28 10 0	46 28 11 0
36 mm	46 36 00 0	46 36 01 0	46 36 02 0	46 36 03 0	46 36 04 0	46 36 05 0	46 36 06 0	46 36 10 0	46 36 11 0
45 mm	46 45 00 0	46 45 01 0	46 45 02 0	46 45 03 0	46 45 04 0	46 45 05 0	46 45 06 0	46 45 10 0	46 45 11 0

Pfeilscheibe – Disque à flèche – Arrow dial

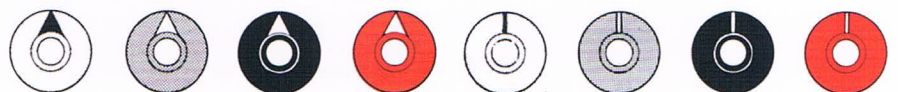

8 mm	standard mat finish	45 08 01 1 45 08 11 1	45 08 01 2 45 08 11 2	45 08 01 3 45 08 11 3	45 08 01 4 45 08 11 4	45 08 02 1 45 08 12 1	45 08 02 2 45 08 12 2	45 08 02 3 45 08 12 3	45 08 02 4 45 08 12 4
10 mm	standard mat finish	45 10 01 1 45 10 11 1	45 10 01 2 45 10 11 2	45 10 01 3 45 10 11 3	45 10 01 4 45 10 11 4	45 10 02 1 45 10 12 1	45 10 02 2 45 10 12 2	45 10 02 3 45 10 12 3	45 10 02 4 45 10 12 4
13 mm	standard mat finish	45 13 01 1 45 13 11 1	45 13 01 2 45 13 11 2	45 13 01 3 45 13 11 3	45 13 01 4 45 13 11 4	45 13 02 1 45 13 12 1	45 13 02 2 45 13 12 2	45 13 02 3 45 13 12 3	45 13 02 4 45 13 12 4
15 mm	standard mat finish	45 15 01 1 45 15 11 1	45 15 01 2 45 15 11 2	45 15 01 3 45 15 11 3	45 15 01 4 45 15 11 4	45 15 02 1 45 15 12 1	45 15 02 2 45 15 12 2	45 15 02 3 45 15 12 3	45 15 02 4 45 15 12 4
21 mm	standard mat finish	45 21 01 1 45 21 11 1	45 21 01 2 45 21 11 2	45 21 01 3 45 21 11 3	45 21 01 4 45 21 11 4	45 21 02 1 45 21 12 1	45 21 02 2 45 21 12 2	45 21 02 3 45 21 12 3	45 21 02 4 45 21 12 4
28 mm	standard mat finish	45 28 01 1 45 28 11 1	45 28 01 2 45 28 11 2	45 28 01 3 45 28 11 3	45 28 01 4 45 28 11 4	45 28 02 1 45 28 12 1	45 28 02 2 45 28 12 2	45 28 02 3 45 28 12 3	45 28 02 4 45 28 12 4
36 mm	standard mat finish	45 36 01 1 45 36 11 1	45 36 01 2 45 36 11 2	45 36 01 3 45 36 11 3	45 36 01 4 45 36 11 4	45 36 02 1 45 36 12 1	45 36 02 2 45 36 12 2	45 36 02 3 45 36 12 3	45 36 02 4 45 36 12 4
45 mm	standard mat finish	45 45 01 1 45 45 11 1	45 45 01 2 45 45 11 2	45 45 01 3 45 45 11 3	45 45 01 4 45 45 11 4	45 45 02 1 45 45 12 1	45 45 02 2 45 45 12 2	45 45 02 3 45 45 12 3	45 45 02 4 45 45 12 4

Stator



8 mm	47 08 01 1	8 mm	47 08 02 3
10 mm	47 10 01 1	10 mm	47 10 02 3
13 mm	47 13 01 1	13 mm	47 13 02 3
15 mm	47 15 01 1	15 mm	47 15 02 3
21 mm	47 21 01 1	21 mm	47 21 02 3
28 mm	47 28 01 1	28 mm	47 28 02 3
36 mm	47 36 01 1	36 mm	47 36 02 3
45 mm	47 45 01 1	45 mm	47 45 02 3

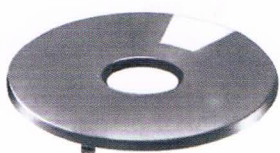

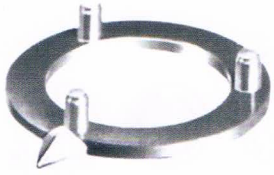

Pfeil – Flèche – Arrow



8 mm	standard mat finish	40 08 00 1	40 08 00 2	40 08 00 3	40 08 00 4	40 08 00 5	40 08 00 6	40 08 00 7
		40 08 10 1	40 08 10 2	40 08 10 3	40 08 10 4	40 08 10 5	40 08 10 6	40 08 10 7
10 mm	standard mat finish	40 10 00 1	40 10 00 2	40 10 00 3	40 10 00 4	40 10 00 5	40 10 00 6	40 10 00 7
		40 10 10 1	40 10 10 2	40 10 10 3	40 10 10 4	40 10 10 5	40 10 10 6	40 10 10 7
13 mm	standard mat finish	40 13 00 1	40 13 00 2	40 13 00 3	40 13 00 4	40 13 00 5	40 13 00 6	40 13 00 7
		40 13 10 1	40 13 10 2	40 13 10 3	40 13 10 4	40 13 10 5	40 13 10 6	40 13 10 7
15 mm	standard mat finish	40 15 00 1	40 15 00 2	40 15 00 3	40 15 00 4	40 15 00 5	40 15 00 6	40 15 00 7
		40 15 10 1	40 15 10 2	40 15 10 3	40 15 10 4	40 15 10 5	40 15 10 6	40 15 10 7
21 mm	standard mat finish	40 21 00 1	40 21 00 2	40 21 00 3	40 21 00 4	40 21 00 5	40 21 00 6	40 21 00 7
		40 21 10 1	40 21 10 2	40 21 10 3	40 21 10 4	40 21 10 5	40 21 10 6	40 21 10 7
28 mm	standard mat finish	40 28 00 1	40 28 00 2	40 28 00 3	40 28 00 4	40 28 00 5	40 28 00 6	40 28 00 7
		40 28 10 1	40 28 10 2	40 28 10 3	40 28 10 4	40 28 10 5	40 28 10 6	40 28 10 7
36 mm	standard mat finish	40 36 00 1	40 36 00 2	40 36 00 3	40 36 00 4	40 36 00 5	40 36 00 6	40 36 00 7
		40 36 10 1	40 36 10 2	40 36 10 3	40 36 10 4	40 36 10 5	40 36 10 6	40 36 10 7
45 mm	standard mat finish	40 45 00 1	40 45 00 2	40 45 00 3	40 45 00 4	40 45 00 5	40 45 00 6	40 45 00 7
		40 45 10 1	40 45 10 2	40 45 10 3	40 45 10 4	40 45 10 5	40 45 10 6	40 45 10 7

Pfeil – Flèche – Arrow

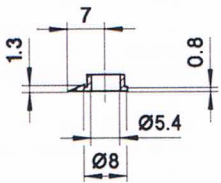

8 mm

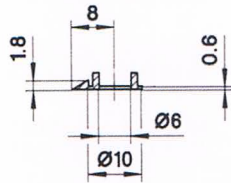

10 mm

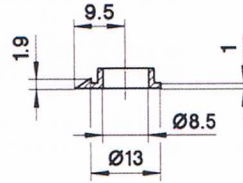

13 mm

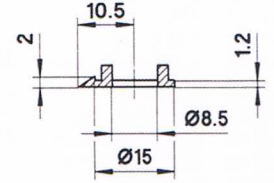

15 mm

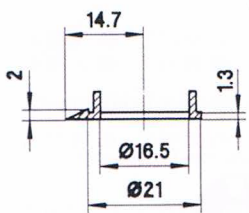

21 mm

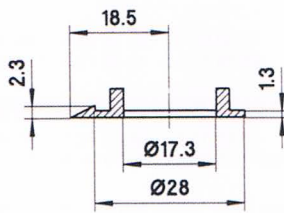

28 mm

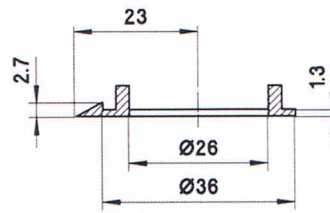

36 mm

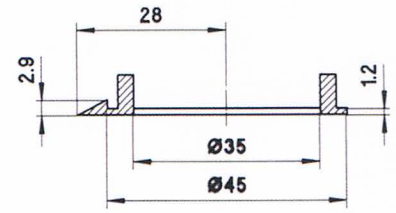

45 mm